

---











---

---

CSOA B B













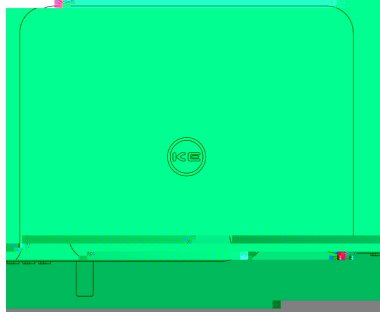

---

---



科林电气 光伏并网逆变器	
产品型号: KLE-G250E-GT25KTL1	
DC 输入	
最大输入电压:	1100V
额定输出功率:	2500W
环境温度:	-30°C ~ +60°C
防护等级:	IP66
安全等级:	
制造商名:	石家庄科林电气股份有限公司





电话: 0086-311-85231087    100-0811-125  
 传真: 0086-311-85231087  
 网址: www.kelin.com.cn

---



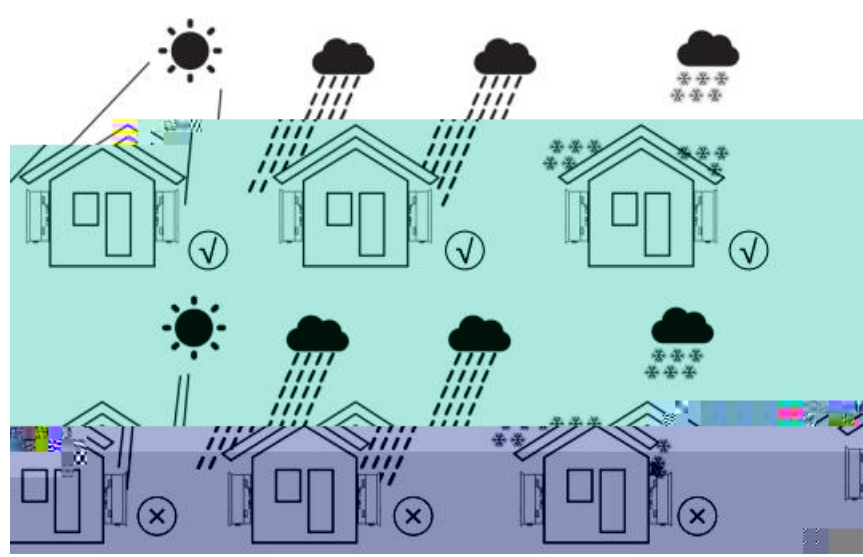



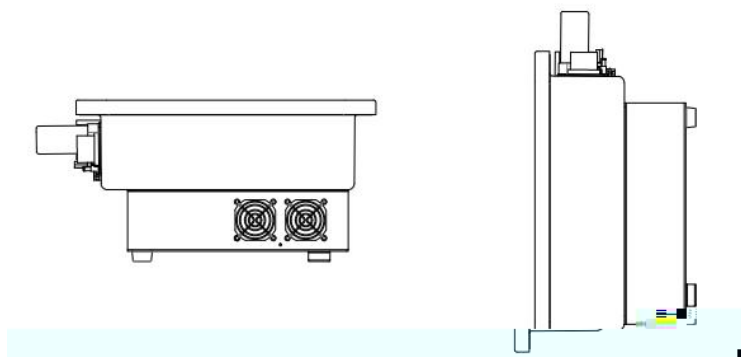
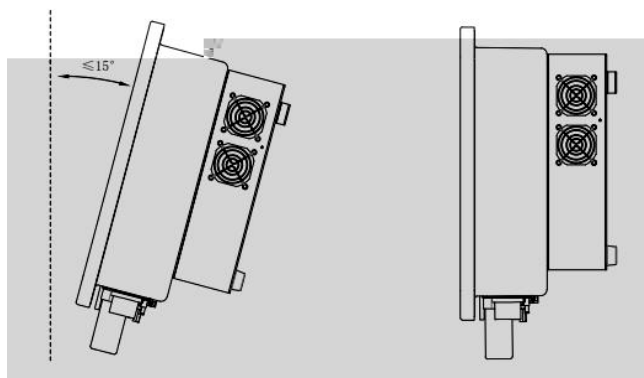

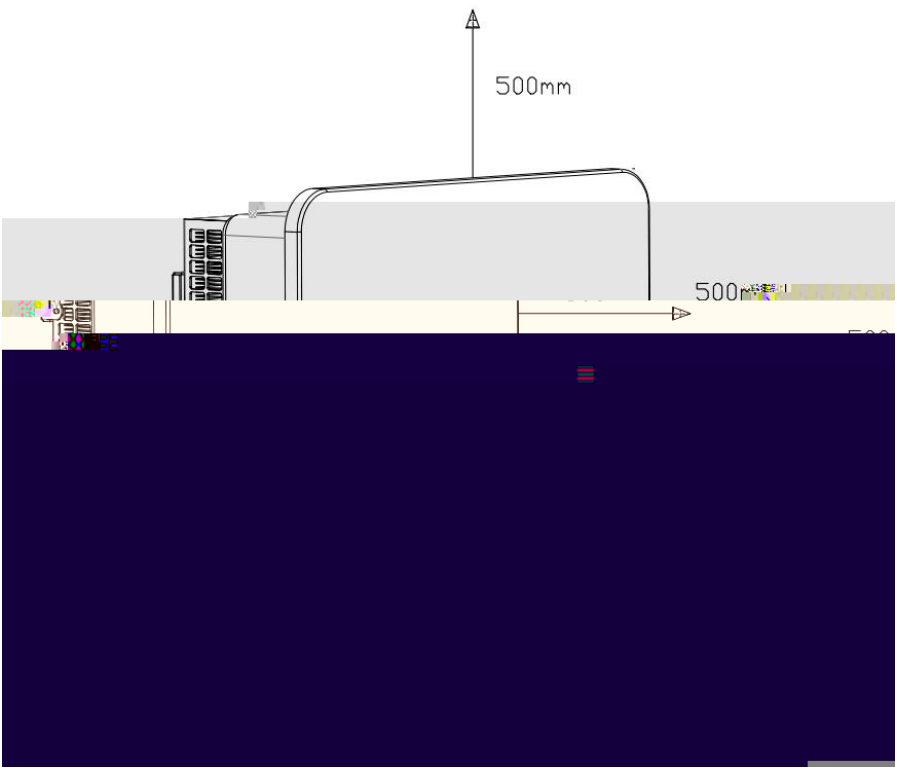

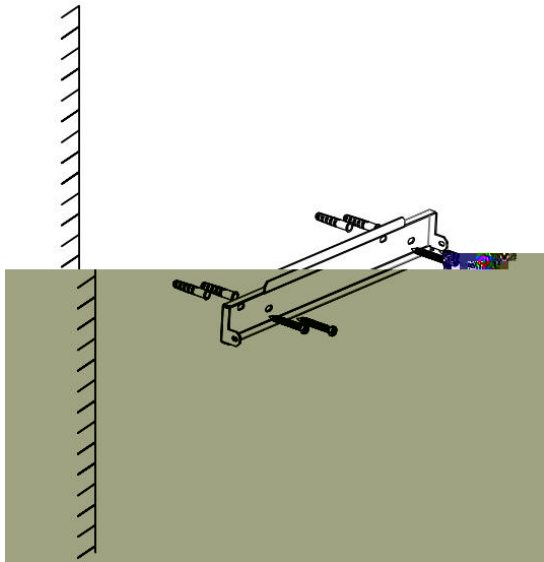
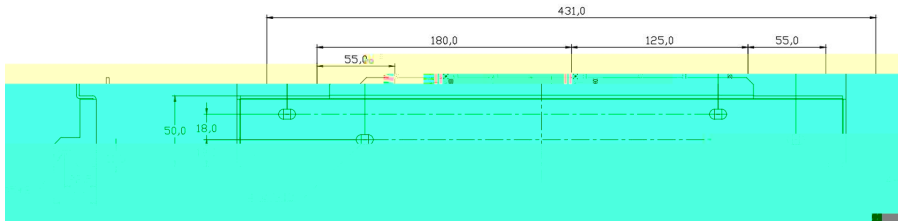

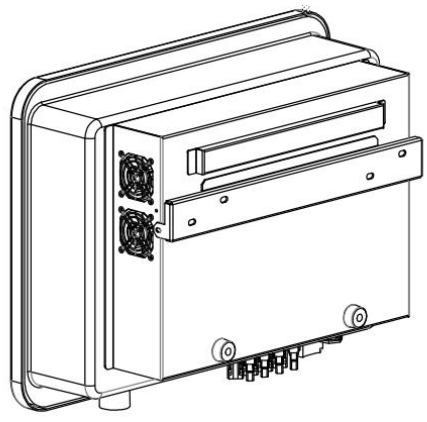
紧固螺丝

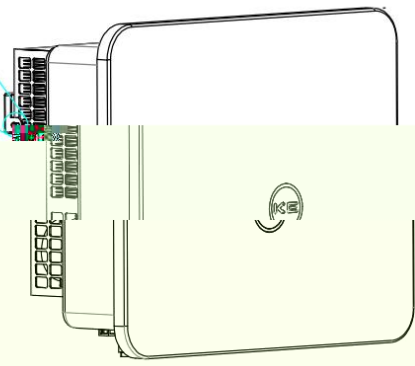
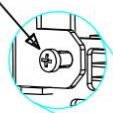



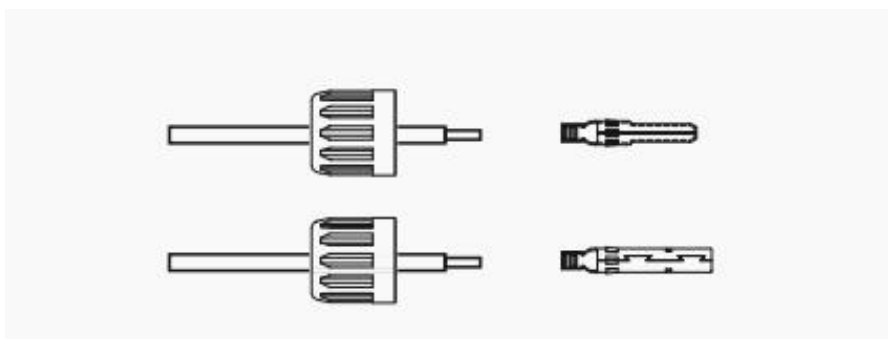
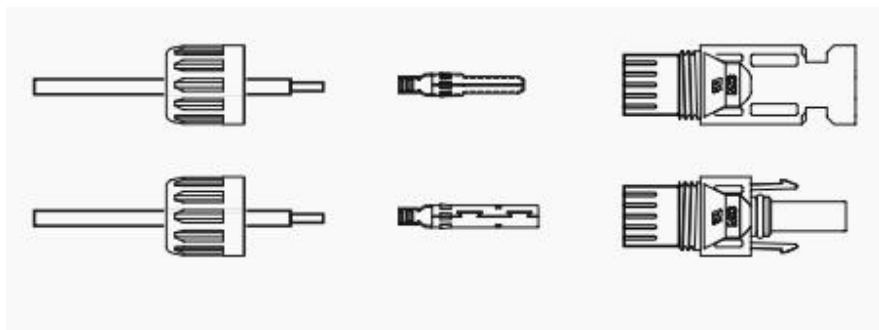
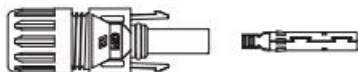

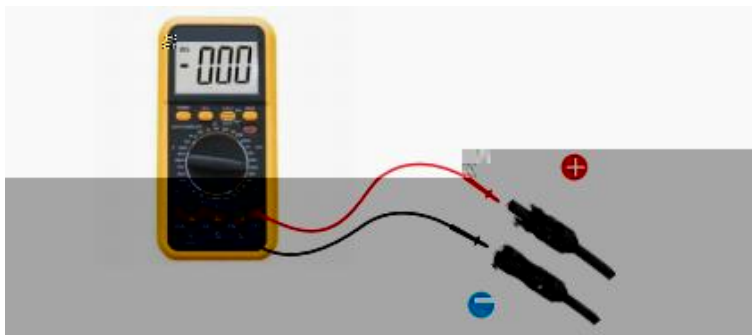
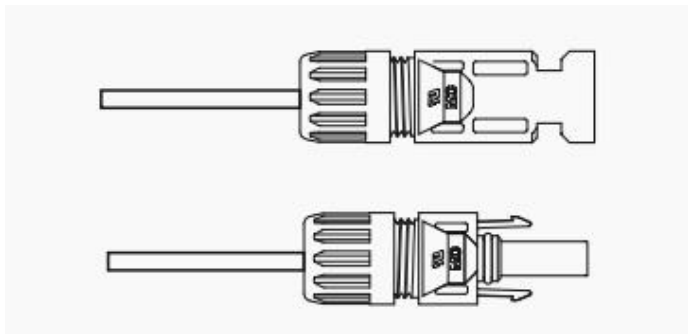
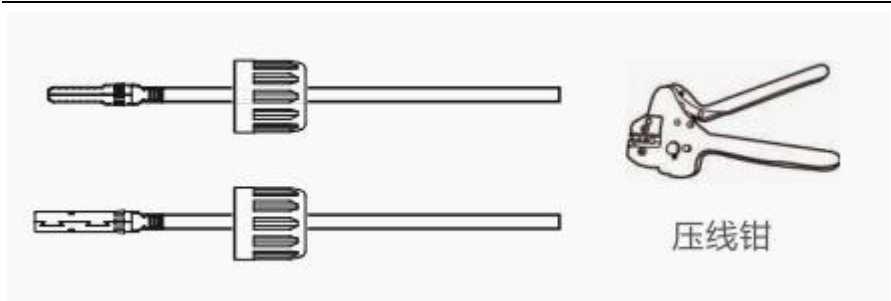

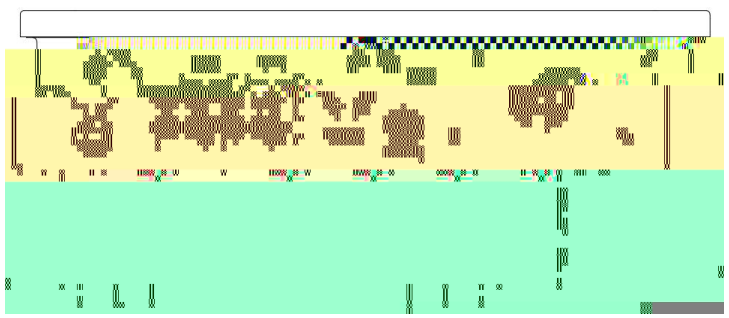

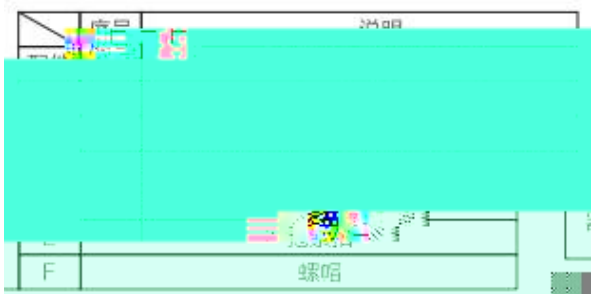
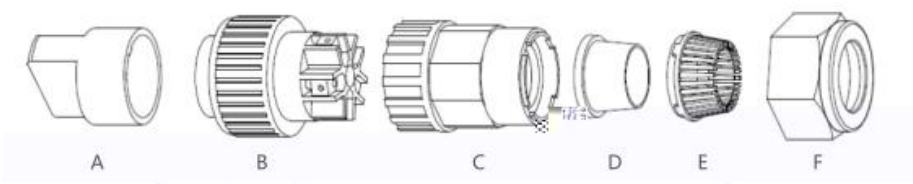

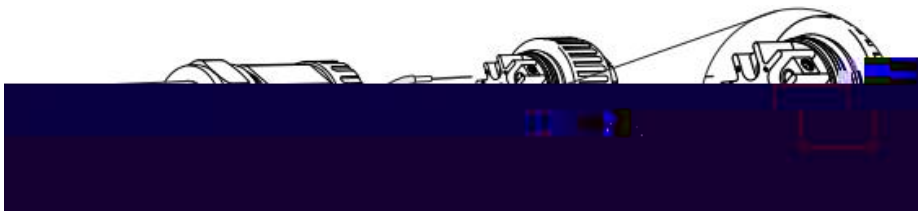
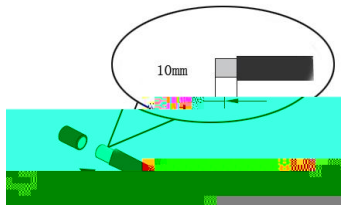
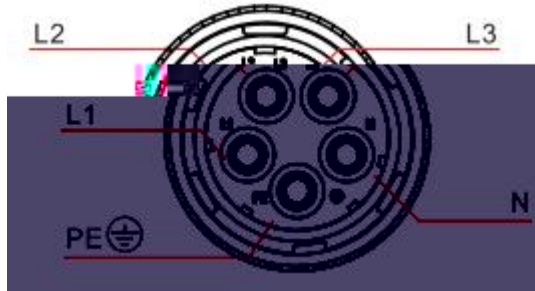

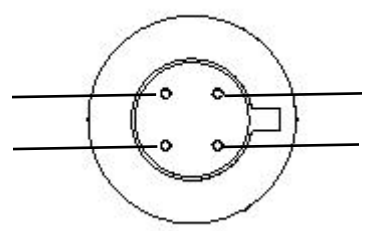
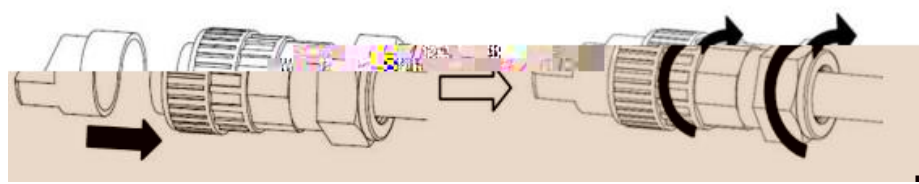
---

---

---

---

---

---



**重要:**

对于并联的多台逆变器,所有逆变器应连接到同一接地点,以确保按值电压连接。

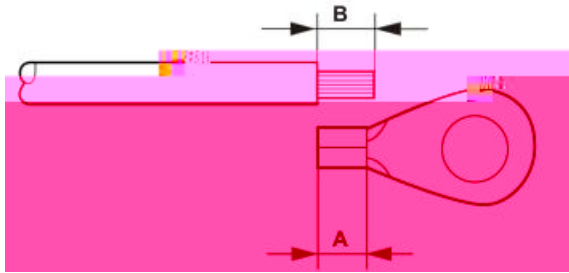

**重要:**

B (绝缘剥离长度) 比A (OT线缆端子压接区域) 长2mm~3mm。

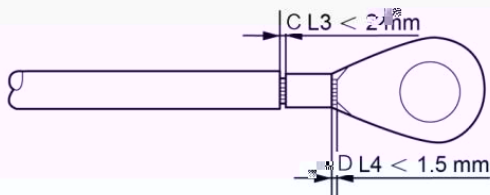



**重要:**

将端子压接到线缆后，检查连接以确保端子牢固地压接到线缆上。

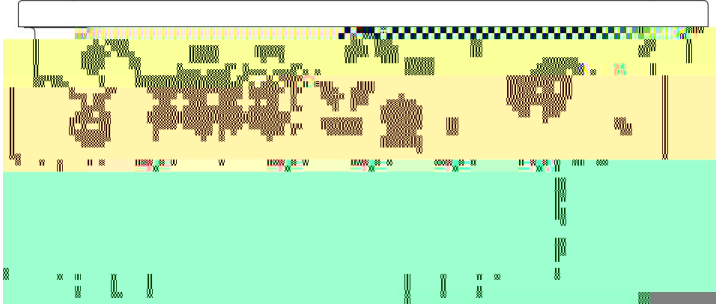

---

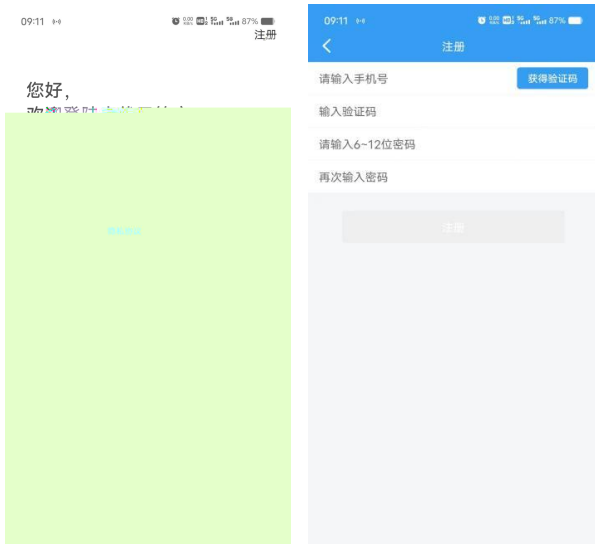

---

09:11

注册

您好,

注册成功

注册成功



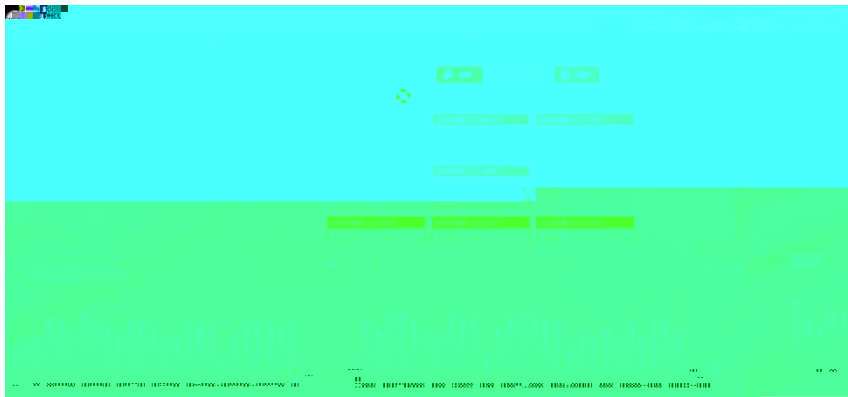
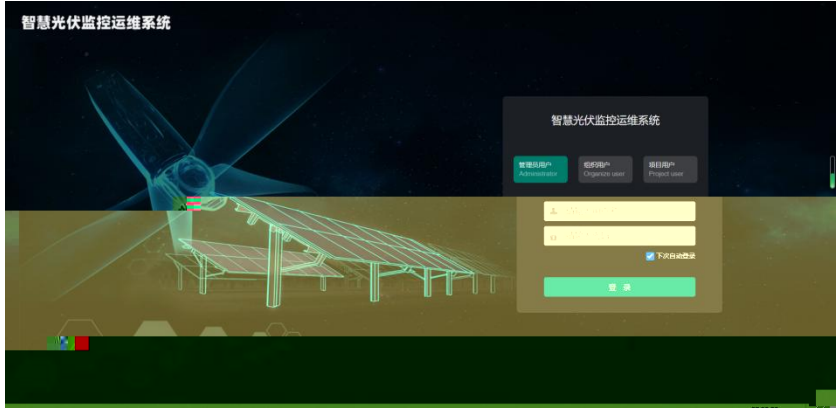

€ \$ €





---